

PRODUCTION PARTNER

Fachmagazin für Veranstaltungstechnik

Four and eight channel amplifiers from Powersoft

Powersoft X Series

The new Powersoft X Series combines high performance with extensive signal management

Review
from issue 10/2015



Text and measurements: Anselm Goertz
Images: Dieter Stork, Anselm Goertz (4)



» ... With the two models of the X Series, the Italian manufacturer Powersoft present a 4- and an 8-channel amplifier with integrated DSP system, remote control and remote access as well as optional Dante audio network interface, which absolutely deserves the name loudspeaker management system ...«

Test | Powersoft X-Serie

With the X Series Powersoft presents its latest product line with the first two models: the X4 with four channels, and the X8 with eight channels. The amps are equipped with TMS320DM816x DaVinci Digital Media Processor / dual-core ARM Cortex A8 / 1.2 GHz DSP. Additionally, a Dante interface is available for an extra cost. The three-phase power supply, which offers flexible connections for different electricity networks and grid-friendly power consumption, has been developed com-

pletely from scratch. The amplifier modules inside the X4 and X8 are identical; with the strength of the respective power supplies designed to correspond to the number of amplifiers. In the X4, two amplifier modules with two channels respectively have been positioned flat and side-by-side, allowing space for Powersoft's typical 1-RU enclosure. For the X8 there is no way around the 2 RU. Here, four of the two-channel amplifier modules have been arranged vertically inside the enlo-

sure. In both cases the module design allows a fast service through the exchange of modules, which can easily be removed.

Special features of the X Series

As known from other manufacturers, the X Series is no longer simply a two-channel power amplifier but a complete loudspeaker management system including all signal processing



functions – the “next generation of power amplification”. As a consequence numerous well-known manufacturers have equipped their amps with complete libraries of setups for their loudspeaker systems. For example, an X8 can supply a small PA and monitors at smaller deployments. Large four-way line arrays can be completely powered by a single X8 or X4. Two channels can be bridged respectively if, for example, a subwoofer requires more power. At 12 dB crest fac-

tor, a channel with an X amplifier provides around 3.2 KW at 4 Ω or 4.3 kW at 2 Ω . When one compares this with Powersoft’s K Series this corresponds roughly to the similar output of a K8.

On the outside the X4 and X8 appear very inconspicuous. The matt black front panel is designed to act as a large curve shaped air intake. The cover can be removed using two large socket screws, so that the air filter mats, which are located behind, can be cleaned

quickly. Only the power switches and the further four or eight respective large backlit buttons serve as control elements. There is no description or labeling in place as the functions are largely self-explanatory: the large button is the power switch, the other four or eight are the mute buttons for the individual channels. By pressing and releasing the power switch quickly, this activates the mute function for all channels. The colored information of the individual switches – with their central





Front view of the X8 and X4 Switches indicate the status of the channels and activate their mute function

and circular illumination – indicate Mute, Signal present, Clip, Limiter and Fault. When looking closely, one can find two small buttons located externally on the front left and right. One of these activates the integrated Wi-Fi module, the other sends a detection

signal to the Armonia software with which the amplifier can quickly be found in complex installation. Vice versa, detection for the amplifier can be called up via the Armonia software, resulting in a flashing of all channel keys.

A little more happens on the rear of both amps. Here, a multitude of analog and digital inputs, network connectors and Speakon connectors present themselves. In accordance with the number of channels there are analog symmetrical inputs, AES/EBU inputs and NL4



A lot of in- and outputs at the rear, the allocation can easily be recognized



Network sockets for the primary and secondary connection of a Dante network. Above the X4, below the X8

Speakon connectors, which feature two outputs each. For the network connection as well as for the primary and secondary Dante audio network two RJ45 network sockets are available.

Two ventilators at the rear draw the incoming air from the front of the amplifier out of the enclosure. The larger ventilators in the X8 operate with a tolerable noise level, the noise level of the

X4 increases substantially at high load. A simple measurement in the lab resulted in a 75 dBA at a distance of 1 m. Even in a standby mode, these were still 46 dBA. As long as the amps are

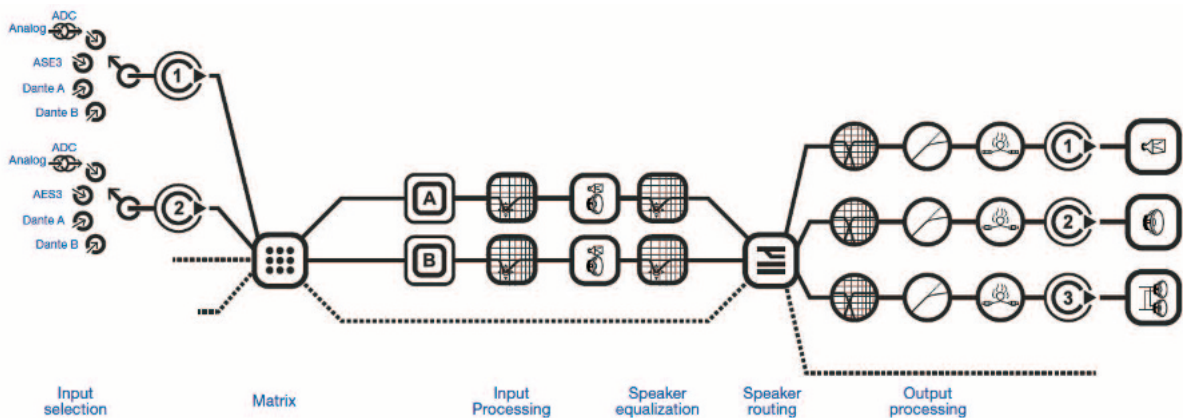

Block diagram of the amplifier with controller. Illustrated here for two inputs and three outputs. (Figure 1)

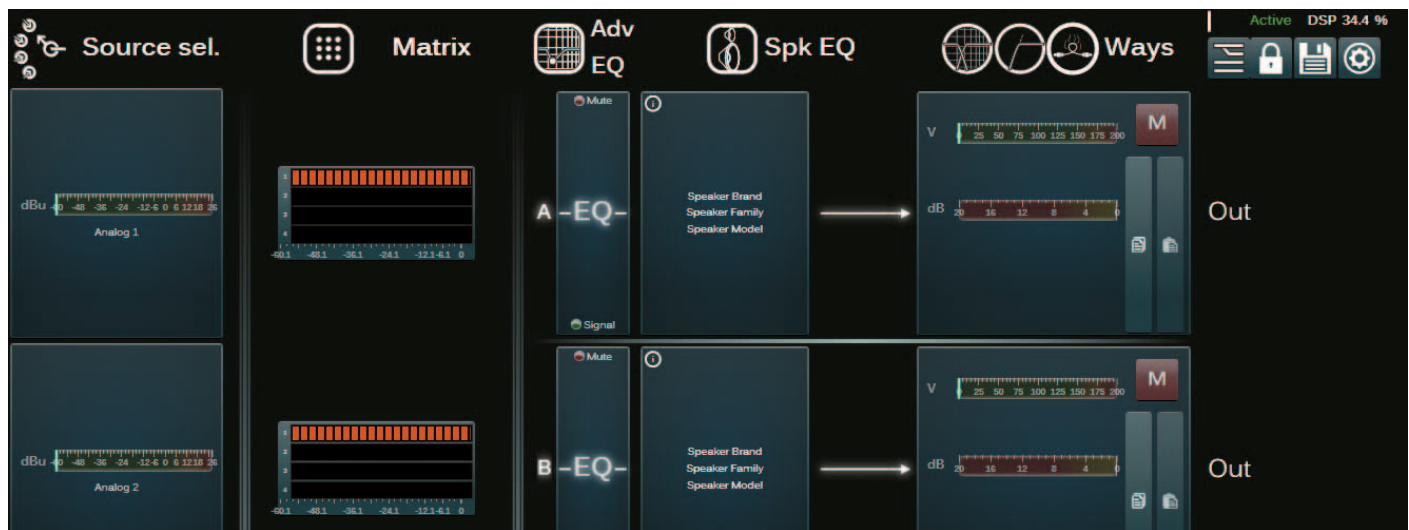

Configuration in the Armonia software (Figure 2)

located in separate engineering rooms or far behind the stage, depending on the noise level of the event, this level is not critical. However, for sensitive applications close to the audience, such measurements are too high.

Controller with Dante network

For an additional 1,000 € the X Series amps are available with an integrated Dante interface. The larger of the two Audinate modules has been installed here, the so-called Brooklyn with a primary and a secondary network interface. With the Brooklyn module users can build redundant networks and transmit up to 64 in- and out-going channels at 48 kHz in parallel. For a redundant operation, two independent star-shaped networks need to be created, whereby the control computer for the Armonia software and the configuration of the Dante network are connected to the primary network. In total, three possibilities to input signals are available: analog, digital via AES/EBU



Wi-Fi onboard An X4 amplifier in the browser view (Figure 3)

(AES3) and digital via the Dante network.

The internal controller additionally allows the possibility of prioritizing the four signals per input. If the first fails,

the second is activated, and so forth. Users can thereby choose between the analog and the AES3 input as well as the two channels from the Dante network. In the Dante controller the amplifiers are displayed with 16 input chan-

nels, which are arranged in the sequence input 1 with channel 1 and 9, input 2 with channel 2 and 10 etc. This is completely independent of the primary and secondary Dante network, which does not appear as such for the user of the amps. Via the priority list, the level and delays can be adjusted so that a possible fall back can happen without jumps in the signal level. Unfortunately, when and how a fall back is triggered is unclear. On this matter an undeniable weakness of the Armonia Pro Audio Suite – which concerns the documentation and the manual – needs to be addressed. Both are rather limited or outdated. As the software does not explain itself in all regards, this leaves one or the other question unanswered and users clueless. Considering the potential of these products, this would not have to be the case.

A good overview of the signal routing and the controller's functions are offered by the block diagram in figure 1. From left to right it shows the choice of hardware input for the four or eight inputs, which subsequently come together in a 4x4 or 8x8 matrix respectively. This is followed by the input processing with the Advanced EQs and the Speaker EQs. The Advanced EQs are equipped with special Raised Cosine Filters (further information below). The Speaker EQ may be a little misleading and should rather be understood as Cluster or Array EQ. The actual speaker processing with X-Over, limiters and EQs for the individual lines follows in the Block Output Processing. The preceding Speaker Routing enables users to supply several outputs from one input for active multi-way systems.

Armonia Software and APP

The processing in all X Series amplifiers – just as in all other Powersoft amplifiers – is configured using the Armonia Pro Audio Suite, currently in the 2.5.2. version, accessed via the network. If a Dante module is included, the access is directed via the primary port. For all devices without a Dante network the two network connections can be daisy-chained from one device to the next. Theoretically this would also be possible for the Dante network – when neglecting the redundancy. For good reason however, most manufacturers do not enable this option.

Having started the Armonia software, the software will automatically browse the connected network with its Discover Function and will show all devices found. Subsequently, these can be modified, grouped and monitored in the Workspace. Figure 2 shows an overview for the first channel of an X Series amp in the Armonia software. Unfortunately, the look of the various Powersoft models is not completely unified, which –

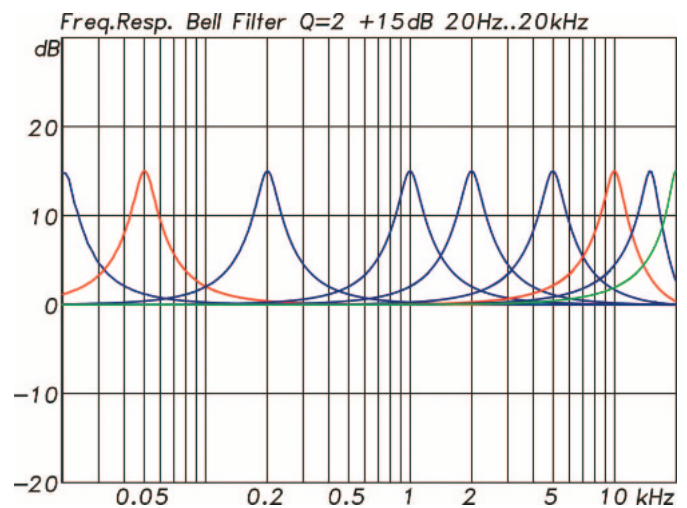

Classic bell filter implemented as Bi-Quads with compensation for the transition from the analog to the digital level. (Figure 4)

due to the development over the years – was to some extent inevitable.

For those who would like to explore the Armonia software in detail, the free download is recommended. All functions are also available offline. Details regarding the individual items can be found in the following chapters. Of course, a complete description of the functions is not possible at this point.

As the amplifier itself does not allow any operation apart from mute, a computer is always necessary for operation. To quickly change a set-up, place a filter or to adjust a limiter would not be possible without a computer if using Armonia software was the only way. To free itself from this dependency, Powersoft has equipped the X Series amplifiers with their own Wi-Fi network modules, which can be accessed directly from mobile devices using all kinds of web browsers. The Safari browser is recommended for iOS-based devices, while Google's Chrome is recommended for all devices using Android or Windows. A short test with a Sony Xperia Smartphone and with an iPad lead to the desired result.

The browser interface is currently being developed and not all functions have been implemented. However in the current version nearly all statuses such as the voltage, power, temperature,

Raised Cosine Filter

The filter in the DSP's Advanced EQ has been implemented as so-called Raised Cosine Filter. Unseen by the user, a large filter bank in the background separated whole spectrum into the individual small band, so that each band's level can be set. If all filters are set at 0 dB, nothing happens. More or less any desired filter can now be created or, more accurately can be synthesized by reproducing the desired filter curve over the level of the individual bands. How exactly this works depends primarily on the number of frequency bands and therefore on the resolution of the frequency range. In the Powersoft DSP the distance of the individual filters is 1/10 octave. The necessary processing power for the filter bank is constantly at the same level as all filter bands are always present. For the actual filter design, this process opens a lot of otherwise impossible options such as the asymmetric filter or the shelving filter with a slope that can be configured according to all requirements.

This special Raised Cosine Filter Bank is available for every channel in the X Series amps. Additionally, the software of-

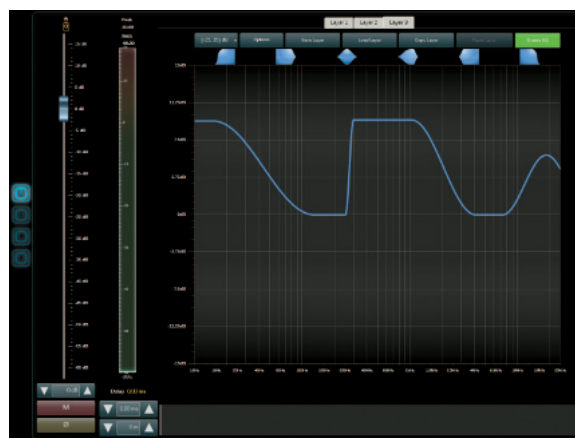

Advanced Filter unit with three layers in the Armonia Software (Figure 5)

fers three layers, which all include the complete functional range and can be split up according to the task at hand. If

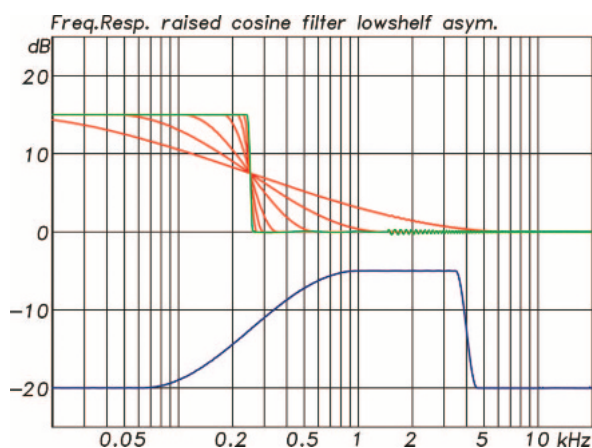

Raised Cosine Filter above a low shelf filter with a flexible slope and below an asymmetrical filter with two freely adjustable slopes; even at very steep slopes there is no waviness with this filter type (Figure 6)

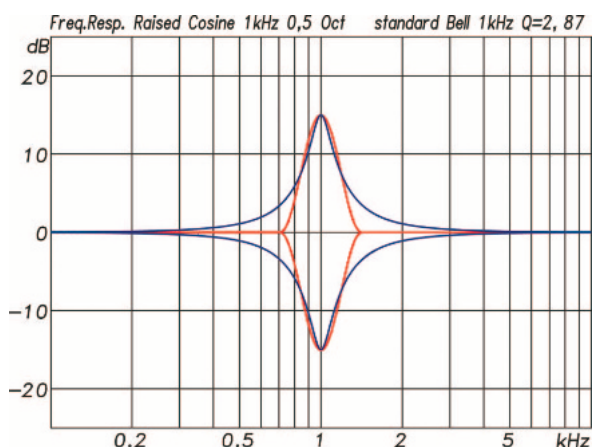

Bell-Filter Comparison as a common BiQuad IIR filter (blue) and as a Raised Cosine Filter (red) (Figure 7)

a layer is already used and locked in the manufacturer set-up, a further one can for example be made available for the system technician and band technician respectively. Internally, all layers are summarized and edited in one filter.

Using the low shelf filters and a filter with asymmetrical slopes, Figure 6 shows which possibilities are available. The range of adjustment for all filters includes the frequency range 20 Hz to 20 kHz, ± 15 dB in the gain and 0.1 to 10 octaves for the slopes. Additionally to these two filter types, filters with a simple bell curve are available, which can also be set in this range of values. The number of filters is not limited.

Among the Advanced EQs the shelf filters are definitely as impressive as these – unlike usually typical with steepness and level – can be set via the width of their slope, which are adhered to absolutely precisely and without any overshoot. The maximum steepness is reached with the setting 1/10 oct according to the resolution of the filter bank.

Differing from the usual value of level or range, the slope width of 0.1 to 10 octaves is also set for the bell filter in the Raised Cosine Filter Bank. The example, in Figure 7 these connections are demonstrated. For the setting 0.5 oct this means a width of 0.5 oct for the ascending and descending slope respectively. For the mid frequency of 1 kHz the filter therefore begins exactly at 707 Hz and ends at 1.41 kHz. An overshoot or similar is not present here either. For comparison, Figure 8 additionally shows a common bell filter with a bandwidth of 0.5 octaves, so that the differences are clearly visible. As for the other filter types, with the Raised Cosine Filter users can precisely realize their desired setting and filters accurately correspond with the desired curve.

output voltage and electricity and gain reduction can be retrieved and monitored. Not yet functional are the filter settings and the loading of set-ups. The current impression of the browser interface is therefore a little ambivalent. Those features, which are already implemented, function fast and well, however some important functions are still missing.

Filter

The filters included in the X Series' DSP controller are classic IIR filter as Bi-Quads (filter structure) and FIR filter. The FIR filter are used for the linear phase X-Over-Filter and for the Raised Cosine functions, which are summarized here as one filter. The latter goes unnoticed for the user. The same applies to the three layers of the Advanced EQs, which function externally as separate Filters, however are processed as one filter internally.

The Block Speaker EQs include eight universal IIR filter per line with the usual functions, a high-pass and low-pass with a maximum 8. order and a custom FIR filter – for example for the realization of a beam-forming filter, which can be calculated with the FIR-Maker (see PRODUCTION PARTNER 7+8/2013). The Custom Filter can process up to 384 taps at a sample rate of 48 kHz, in correspondence with a length of 8ms. The same is true for the Custom FIR Filter in the Block Output Processing. Here too, 16 IIR filter and again one high-pass and one low-pass is included per line. With the help of these filter blocks the typical controller processing for the individual lines of an active loudspeaker can be set. For the high and low passes linear phase FIR filter are available additionally to the usual characteristics such as Butterworth, Linkwitz-Riley and Bessel.

Compensation for digital filter

If one has a look at the filters in detail, there is the issue of the progression correction of higher frequencies of the traditional IIR filters. The curve progression of an analog filter is transformed (z transformation) to a digital level, through approximation to half of the sampling rate a compression of the curve progression develops. A bell filter with a certain fixed quality would therefore be narrower at 10 kHz than at 1 kHz, which of course should not be

the case. With an appropriate compensation this can be prevented until just before half of the sampling rate. At 48 kHz this fits for the audio frequency range until 20 kHz. Figure 4 shows the curves of a simple bell filter with a quality of 2.0 and a gain of +15 dB, which was set and measured between 20 Hz and 20 kHz. The compensation works well and the curve progression with a mid-frequency of 20 kHz remains without distortion in the range less than 20 kHz.

IIR- and FIR-X-Over

FIR filter for an X-Over function for loudspeakers in one form or another have become standard in nearly all high-quality controllers. In comparison to the typical IIR filters (IIR = Infinite Impulse Response), this filter type with a non-feedback structure (FIR = Finite Impulse Response) allows settings with independent amplitude and phase sweeps. If, for example, one would like an X-Over filter with a steepness of 24 dB/oct, with an IIR filter as well as an analog filter this is always accompanied by a phase rotation of a total of 360°. This so-called minimal phase connection is inevitable for this kind of filter. A FIR filter, however, allows users to set the desired amplitude response of the filter without a phase rotation, which is then a linear phase filter. A FIR filter also allows a very steep slope without the associated strong phase rotation. For minimal phase filters a steepness of 24 dB/oct is regarded as acceptable with respect to phase rotation and delay distortion. Everything beyond becomes problematic when it comes to audio. With the high and low passes as FIR filters, this problem area can be avoided.

However, the FIR filters are not without their drawbacks. On the one side they need considerably more processing power and therefore more DSP capacity than the IIR – which in itself isn't the end of the world in view of modern DSPs – and depending on their length they create a latency, which is nearly always unwanted. For the linear phase FIR filter this is determined by the filter length and the scanning rate and is proportional to the filter's resolution in the frequency range. In other words, the more a FIR filter has achieved – for example considering the slope's steepness – the longer a filter has to be, the longer the latency will be. As the resolution is linear over the frequency, the demands of the low frequencies are considerably higher than the high frequencies. This, however, is only true for linear phase filters where the latency is a result of the filter function as such and is not necessarily connected to the implementation of the filter as an FIR filter. If one allocates the FIR filter with a minimal phase or mixed linear/minimal phase function, the latencies are correspondingly shorter. The wide-

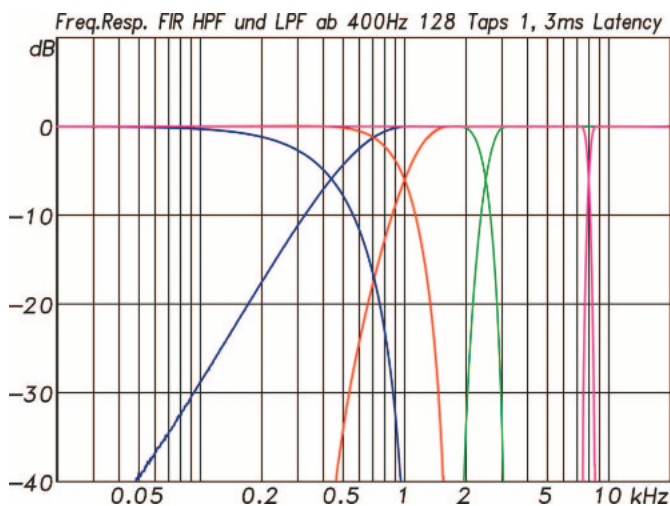

FIR X-Over filter *The length of the FIR filter is limited to 128 taps. Towards the low frequencies the steepness therefore decreases. The corner frequencies under 400 Hz cannot be used. (Figure 8)*

spread opinion that a FIR filter is always accompanied by a latency of half of the filter's length is therefore not true: the latency only depends on the set filter function.

If one wants a complete linear phase filter, the latencies need to be considered, especially during live productions. Powersoft has therefore limited itself to a short FIR filter with 128 taps and a fixed length of 1.3 ms in the linear phase high and low pass filters. That has the advantage that such a filter can be hidden in the amp's constant basic latency of 2.56 ms without the user having to think about this when choosing the FIR filter. On the other hand, there is of course the limitation of the short filter: the decreasing slope steepness in the low frequencies. The adjustment range for the corner frequency of the FIR high and low passes therefore begins only at 400 Hz where nearly 12 dB/oct steepness are achieved (dark blue curve in Figure 8). At 12 kHz nearly 600 dB/oct are achieved with the same filter length (pink curve). Viewed realistically, the linear phase X-Over can therefore be used above around 800 Hz and therefore typically for the separation of mids and highs.

Measurements

We always begin with measurements of the X Amps with the frequency response. Depending on the load there are small

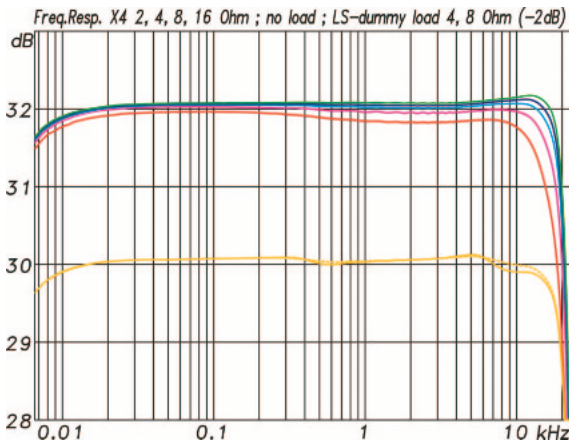

Frequency response with 2 (red), 4 (pink), 8 (light blue) und 16 Ω (dark blue) load resistance and with 4 and 8 Ω loudspeaker dummy loads respectively (displayed with an offset of -2 dB orange). Green curve without load. (Figure 11)

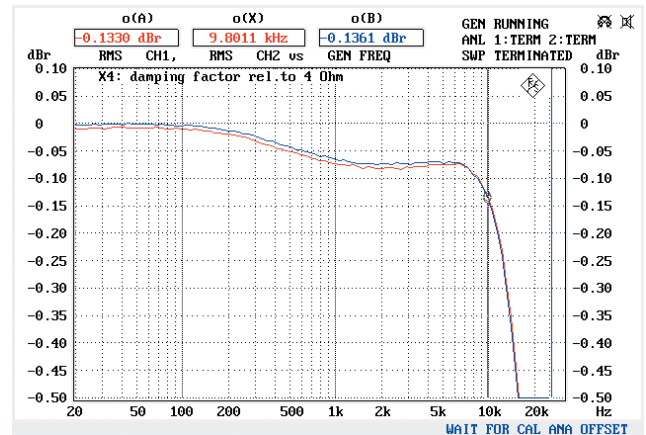

Damping factor representative for channels 1 and 3 in subject to the frequency and a load of 4 Ω . Visible is the loss in level with load in comparison to a measurement without load. (Figure 12)

fluctuations and a change in behavior regarding the output low passes. Under 10 kHz this takes place in on a scale of 0.1 dB and is therefore negligible. Only in the extreme case for a load of 2 Ω did the curve decrease by 2 dB at 18.5 kHz.

When measuring the damping factor, a small measurable problem occurs. With the common sweep method the amplifier

reacts ambiguously. A stable result was only readable for a measurement over using the R&S UPD with sinusoidal signals in frequency steps. The UPD does not allow for a direct conversion of the loss of level into a damping factor. Figure 12 therefore shows a direct measurement for a loss of level for a 4 Ω load in comparison to non-load. At 100 Hz the measurement is -0.05 dB in accordance with a damping factor of nearly 2,000. At 1 kHz an amount of 125 can be measured, at 10 kHz an amount of 66.

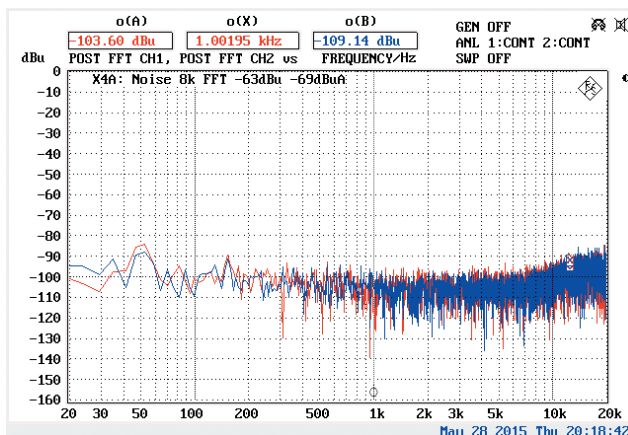

Interference spectrum at the output representative for channels 1 and 3. With an analog input -63 dBu, with digital -65 dBu. A rated 6 dB less respectively. The maximum output voltage is 44 dBu. A rated this results in a dynamic range of 115 dB. (Figure 13).

Additionally the user can set a cable compensation, which is already known from the K Series. It is known that cable and connector worsen the actually high damping factor of modern amplifiers. This can be overcome by including an outgoing line to the speaker or by estimating the impact of the cable and compensating this beforehand. To do so, the user enters the length and profile of the loudspeaker cable in use and the software will calculate the line resistance. For example, for 20 meters with a profile of 2,5 mm² this comes to 0,3 Ohm and the user will adjust the negative internal resistance at the amplifier to -0,3 Ohm. The negative internal resistance can also be achieved with overcompensation in the negative feedback. However, such a concept also tends to be instable and therefore also has a tendency to oscillate, which would of course be fatal. As soon as the cable compensation is used, the amplifier is limited in its bandwidth to a maximum of 400 Hz. Its use therefore only makes sense for subwoofers where a good damping factor is especially important.

Limiter

With the limiter functions of an amplifier or a controller the question always arises, what should be prevented or protected. In the case of the X Series, the amp already includes its own limiter, which prevents a clipping or overload of the amp or the power supply. Understandably the user has no access to this limiter. Via the Armonia software, five further limiters can be set to protect the loudspeakers. These can be differentiated between a current, voltage and power limiter. The current limiters act independently of the load. The voltage limiter measures the real output current and the power limiter calculates the output power depending on power and voltage.

The current and the voltage limiter both act as RMS limiters, which means that the measured value is the effective value of the power or rather than the RMS power. Additionally to the threshold value the attack and release times can also be set. Figure 10 below shows a measurement example with time constants of 0.5 and 2 s respectively for a threshold of 5 A_{eff} or 200 W RMS. Both result in an 8 Ω load in an output voltage of 40 V_{eff}, which are strictly adhered to here.

With current limiters, one needs to take a closer look. Here to there is an RMS limiter, in which effective values can be set as limits. Additionally hereto is a peak limiter, which evaluates the peaks of the output voltage with short time constants und – depending on the setting – will let signal peak pass up to a certain duration. The measurement example for this is in the middle of Figure 10. In the green signal path a short peak is allowed in the beginning before the peak limiter intervenes and limits the voltage to a peak value of 100 V_s. Significantly later with a much longer attack time constant of 1 s, the RMS limiter also intervenes.

Nonetheless time and again there are cases in which a certain voltage is not allowed to be exceeded – not even for a short amount of time. To achieve this, there is a clip limiter, which intercepts everything about the limit without a time constant. For the clip limiter the limit is also set as a peak. Figure 10 above shows the measurements for this for a value of 100 V_s

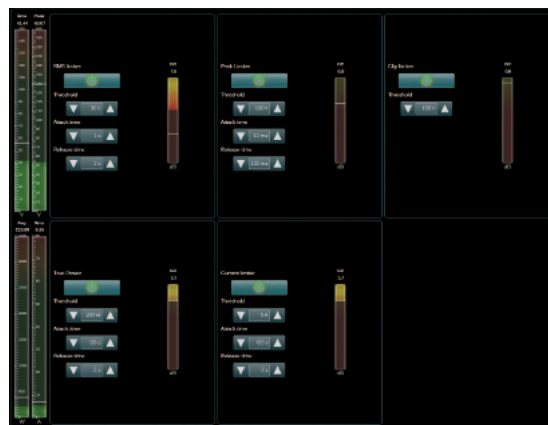

Diverse limiter settings in the Armonia software. For the output power clip, peak and RMS limiters are available. An additional RMS limiter is included for the output current and the output power. (Figure 9)

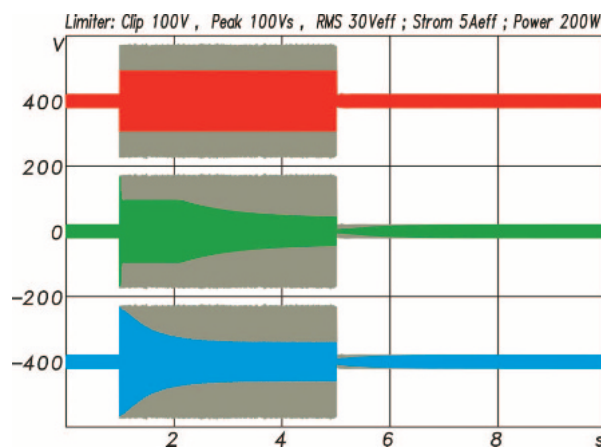

Measurement example for the limiters (Figure 10)
 above: clip limiter at 100 V_s
 middle: peak limiter for 100 V_s and RMS limiter for 30 V_{eff}
 below: voltage limiter for 5 A_{eff}
 In grey the burst signal respectively without the limiter

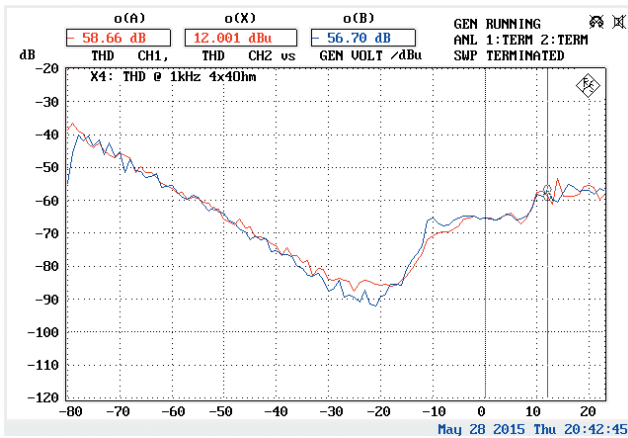

Distortion factor (THD) at 1 kHz and $4 \times 4 \Omega$ load. CH1 (red) and CH3 (blue) subject to the input level (x-axis) (Figure 14)

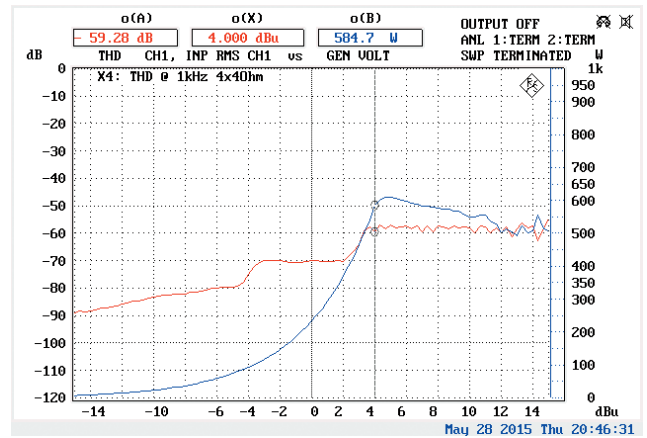

Distortion factor (THD) at 1 kHz and $4 \times 4 \Omega$ load subject to input level. At +4 dBu (600 W) the limiter intervenes. Presented are: THD (red) und performance (blue) per channel (Figure 15)

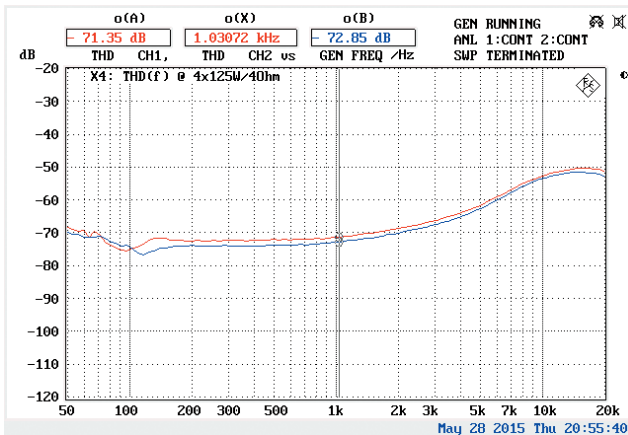

Distortion factor (THD) with $4 \times 4 \Omega$ load (CH1 red, CH3 blue) subject to the frequency at a performance of 125 W per channel with (Figure 16)

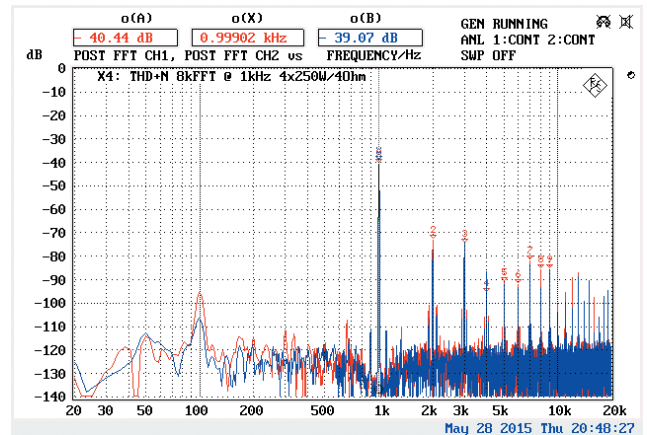

Intermodulation distortion (THD+N) at 1 kHz and 4Ω load (CH1 red, CH3 blue) with a performance of 250 W per channel (Figure 17)

Signal to Noise

The interference distance is especially important for amplifiers, if a high frequency driver with high sensitivity is to be directly connected – in other words without a pre-damping using a passive point. If a tweeter reaches a sensitivity of 100 dB for 2.83 V/1m, with a noise level of -65 dBu at the output of the

amplifier the noise level of the loudspeaker equals 100 dB – 11.3 dB – 65 dB = 33.7 dB at a distance of 1 m. If and when this figure is relevant of course depends a lot on the application. For levels of this size an A rating is definitely sensible, as the Powersoft amplifier gains an additional 6 dB. In relation to the maximum output voltage of just under +44 dBu, a dynamic of 115 dB is achieved which corresponds with the data sheet.

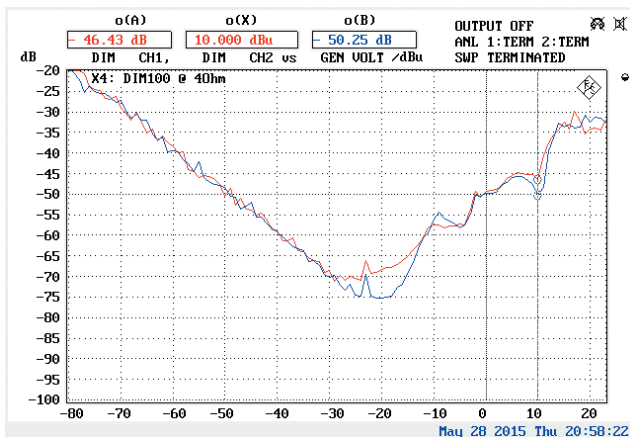

Intermodulation distortion DIM100 at $4 \times 4 \Omega$ load (CH1 red, CH2 blue) (Figure 18)

For the analog input the X Series amps work with stacked AD-converters that accept a maximum input voltage of +25 dBu and in themselves achieve a measured S/M of 124 dB.

Equalization Measurements

For the equalization measurements the data sheet specifies a measurement of less than 0.5 % and typically less than 0.01 %. In dB these correspond to -42 dB and -80 dB respectively. To this end, Figures 14 and 15 show a course of the THD values, which amount to -80 dB per channel with 4Ω for a performance under 100 W. Additionally, there is a peak in the THD curve of -70 dB to around 400 W. If the limiter inside the amplifier comes into play, the values are located at just over -60 dB. The data included in the data sheet are therefore fully met. It can additionally be noted that the limiter operates cleanly and does not cause larger distortions.

Subject to the frequency (Figure 16) the distortion values above 1 kHz increase with the decrease of the negative feedback with around 6 dB/Oct, so that the values at 10 kHz lay at around -53 dB. Such a behavior can be observed for a lot of equipment and is symptomatic for circuits with negative feedback, therefore virtually for all amplifier stages.

The spectral composition of the harmonic distortion in Figure 17 shows a good-natured dominance of k_2 und k_3 proportions,

but also quite a lot of components of a higher order, which – although less than ideal – can hardly be reduced for Class-D amplifiers.

For the transient intermodulations the behavior is reflected from the THD measurements. Very good values of -75 dB are achieved for low power, which then increases to -50 dB above around 100 W. As expected, the use of limiters above an input signal of +10 dBu becomes increasingly noticeable, where the values increase to -35 dB. The latter is owed to the difficult signal for the limiter, where a value of -35 dB in the working range of the limiter is uncritical.

Performance values

The performance values of the X Series were determined according to the method, which we introduced in 2012 for all our tests with load impedances of 2, 4, 8, and 16 Ohm with simultaneous load of all four channels. For these measurements three fundamentally different kinds of test signals were applied, which allow a differentiated assessment of the amplifier's characteristics.

For all impedances, measurements are carried out:

- with constant fitting sinusoidal signal to assess the use of RMC limiters, the current limiting in the power supply or the limitation of the power consumption
- with a noise signal, that is similar in spectral distribution and crest factor to a mid music signal. With this measurement it can be assessed when the amplifier – due to dense music material and full level control – reaches its limits and reacts with limitation or an emergency shutdown.
- with sinus bursts of various lengths and different tact ratios. Additionally to the standard measurement EIAJ with a 8/32 tact ratio, with this measurement it is possible to which brief peak loads the amplifier is capable of delivering depending on the other workload.

For each signal type the results are presented in a clear way using bar diagrams.

For the performance values it must be noted that these are calculated from the respective measured voltage value as peak values (!) by 1.41. This enables a direct comparison to the measurements with constant sinusoidal signals. For the Burst measurements, one could also describe the value as short-

Power supply

Both X Series amplifiers have been equipped with newly developed power supplies, which allow for operation with one, two or three phases from the power grid. Considering the performance values this only seems consequential, as the power capacity taken from the power grid can at best be tripled. As there is no standardized 3-phase-connection, which would be integrated in a 1 RU enclosure, Powersoft has opted for large 5-pole Euroblock Phoenix connectors, which also safely accept large wire sizes. A 3-phase connection with a 10 A protection or a single 16 A phase are recommended for the X4. For the X8, a 32 A wire with only one phase or 3 phases with 16 A respectively should be used. The operation is possible with one phase, with two phases (with or without neutral wire) and with three phases

(with or without neutral wire). For three phases users can additionally vary between star and triangle operation. As can be seen in the optimal use of the neutral wire for two and three phases, this is kept current-free thanks to the power supply. The otherwise feared failure of the neutral wire therefore does not affect the Powersoft amplifiers in any way.

In principle the power supplies work with a PFC (Power Factor Correction), which attempts to ensure a minimum of harmonics of current in the power supply from the power grid. Ideally, the amplifier should behave close to a resistive load.

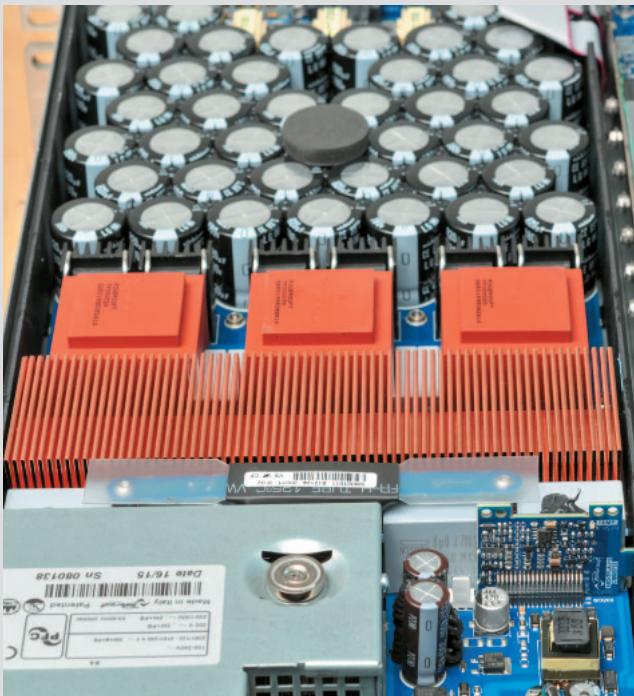

3-phase power supply in the X4



3-phase connection with a large 5-pole Euroblock Phoenix connection. Depending on requirements, both amplifiers can be operated with one, two or three phases.

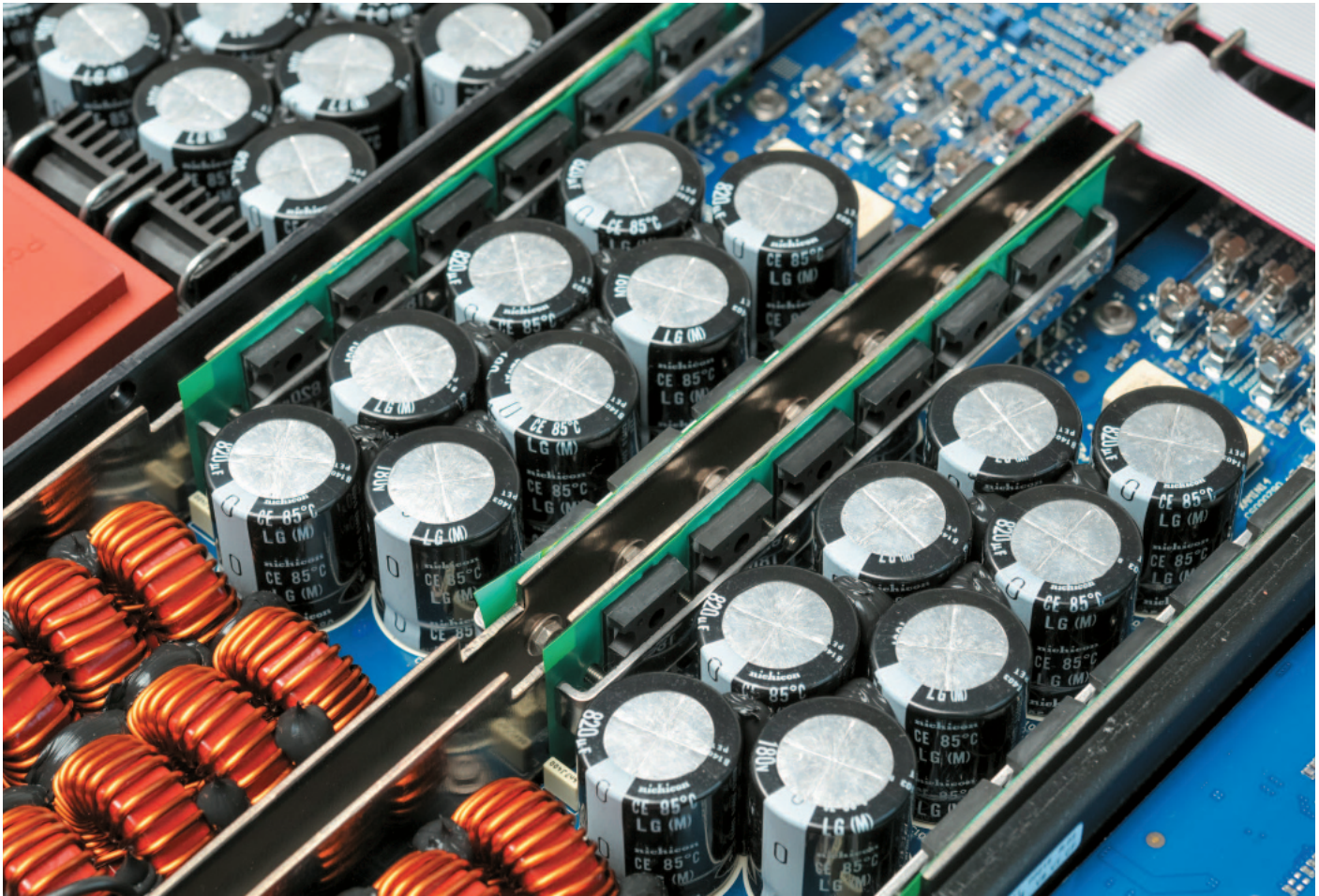

Two amplifier modules each with two channels in the X4, the modules are identical in the X4 and X8.

time RMS. The following three graphics from Figure 19 to 21 show the results.

All measurements were performed on a 3×16 A power supply with C characteristic, so that there was no fear of limitation by the power supply. The comparative measurement of the X4 in the 1-phase and 3-phase modus resulted in no differences in the maximum output power. Only when the 8-channel X8 is working to capacity with all channels is the 3-phase connection mandatory if one limits oneself to 16 A per phase. As the amplifier modules in both amplifiers are identical and the measurement technology for the power grid is

only available for 1-phase measurements in the lab, all performance measurements were carried out with the X4 in a 1-phase modus.

The maximum continuous performance of the X4 for a 1 kHz sinusoidal signal with simultaneous load of all four channels lays – depending on the load impedance – at 580 to 689 W. At 2 Ω the power limit and the thermo limiter respectively intervene, limiting the performance to 700 W. When measures with a 12 dB crest factor noise the values are significantly higher. The measured output voltage at 4 Ω then is 322 V_{ss} (peak-peak). If one calculates

the effective value from this – comparable to a sinusoidal signal – and from this the performance at 4 Ω then one receives remarkable 3.2 kW. The limit here is the highest possible output voltage so that the values for 8 and 16 Ω are nearly halved. During the six-minute measurement the performance at 8 and 16 Ω was available until the end of the test period. At 4 and 2 Ω the thermo limiter in the amplifier intervened again.

Subsequently an endurance test took place. For this, the amplifier was operated with four 4 Ω load resistances and was loaded with an EIA426B noise signal (20 Hz to 20 kHz) with 12 dB crest

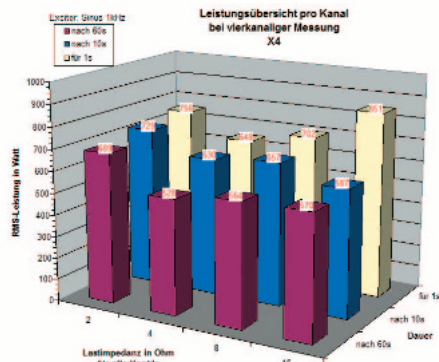

Performance values with simultaneous load of all channels and measurement with a constant sinusoidal signal (performance as RMS value) (Figure 19)

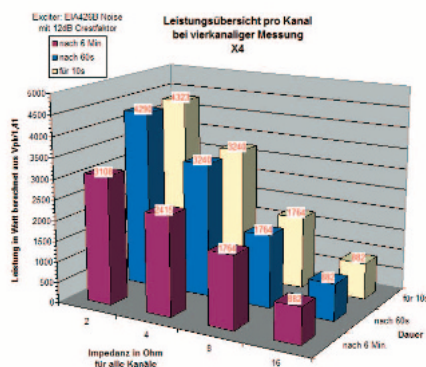

Performance values with simultaneous load of all channels and measurement with a noise with 12 dB crest factor (performance as RMS value calculated from Vpeak) (Figure 20)

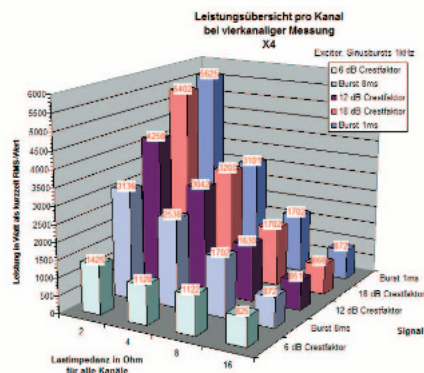

Performance values with simultaneous load of all channels with sinus burst and burst signals with various crest factors (performance as RMS value calculated from Vpeak) (Figure 21)

factor. The RMS value of the dispensed performance amounted to $4 \times 400 \text{ W}$ and reduced itself during the 15-minute test to $4 \times 270 \text{ W}$. At the end of the 15 minutes, the amplifier showed an operating temperature of 63°C .

Degree of efficiency

Regarding degree of efficiency the following basic parameters for the power consumption from the power grid can be measured for the amplifier:

Standby:	4 W
No signal:	107 W
Max. power 12 dB CF:	2,260 W

All measurements took place with the X4 in a 1-phase modus. The last value with 2,260 W is the power consumption if the amplifier is working to capacity with a signal with 12 dB crest factor. The maximum output voltage of the amplifier at 4Ω amounts to around $322 V_{ss}$ (peak-peak). With a crest factor of the signal of 12 dB this corresponds to an effective value of 40 Veff and therefore an effective or RMS value of 400 W per channel. With four channels and an efficiency of around 75 % this is 2,133 W plus the 107 W minimum load and therefore a sum of 2,240 W. With a load one needs to add the increased power consumption of the fans, making the value of 2,260 W quite comprehensible.

In the second step, the ratio between power consumption and power output with various loads was tested in a measurement series.

Additionally to the minimum load, the relevant values are the power output and the degree of efficiency. Depending on the circuitry, the latter can be more or less dependent on the control by the amplifier and the signal form. Figure 22 shows the relation for the X4 amplifier. Corresponding to the measurement series the red curve demonstrates the relation between the sum of the effective power output of all four channels (x-axis) and the power consumption from the power grid (y-axis). If there is no power output, one can identify the minimum load of nearly 107 W. The blue curve is the result of the power consumption minus the minimum load. The pink curve acts as a comparison and would be the ideal course for a 100 % degree of efficiency, if the

Overview Powersoft X4

Performance

4 Ω/4 Ch	Sinusoidal 10 s	12 dB CF 60 s	Peak 1 ms
in W pro Ch	630	3.240	3.240

Noise	dBu		dBu(A)	
analog/digital in	-63	-65	-69	-71
Dynamic	dB		dB(A)	
analog/digital in	107	109	113	115
f[Hz]	20	1 k	20 k	
Gain dB	31.9	32	30	
Phase °	+7	-3	-17	
HP-Filter	<5 Hz			
TP-Filter	22 kHz			

f[Hz]	100	1 k	10 k
CTC dB Ch1->Ch2	-95	-85	-47
CMRR dB	-80	-80	-72
DF rel. 4 Ω	2.000	125	66

THD(f) @ 25 % Power [dB]	Min.	vor Clip
THD 1kHz	-90	-65
DIM100	-75	-45
SMPTE 60/7k	-75	-52
DFD IEC268	-95	-80

Power / weight 864 Watt/kg

Price / power 0,55 €/Watt

15 min. endurance test with = 4 × 400 W / 4 Ω RMS (12 dB CF)

Passed but power was reduced to 270 W per channel after 15 min.

Temperature 63°C

Weight 15 kg

Height 1

RRP incl. tax 7,138 € (with Dante + 1.190 €)

Firmware V 1.6.2.3

S.Nr. 080138

Power supply HF switching mode with PFC

Circuit Class-D

Remote Armonia Version 2.5.2

– All performances are measured with a 4-channel load

– Power/weight and price/power at 4 Ohm for all channels summarized at 12 dB crest factor

– Dynamic measured calculated from peak power and noise level

– CTC = Crosstalk Cancellation at 10 Watt

– CMRR = Common-Mode Rejection Ratio

– DF = Damping Factor for 4 Ohm

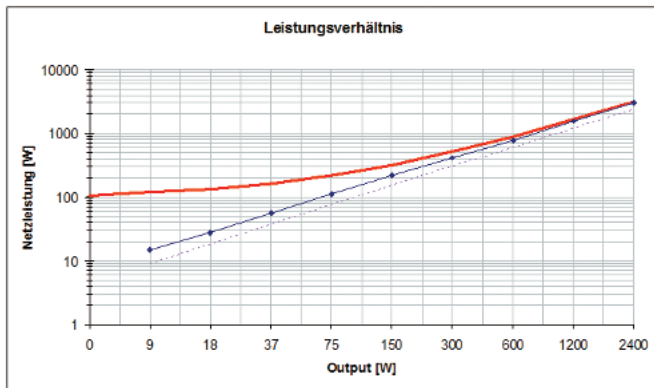

Performance ratio Power output (x-axis) in relation to the power consumption (y-axis) as red curve. In blue the values minus the minimum load of W, which the amplifier creates. In pink, the ideal curve for a 100 % degree of efficiency (Figure 22)

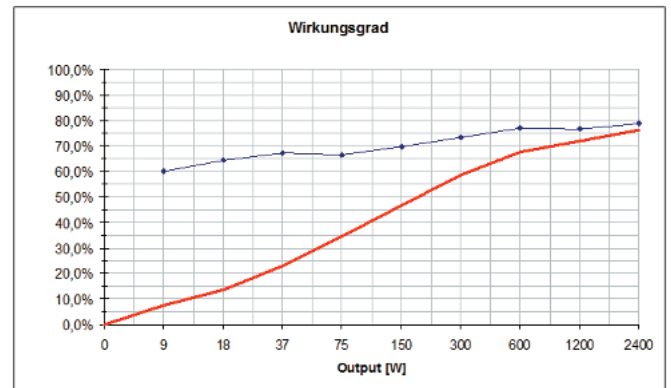

Degree of efficiency of the am in % dependence of the power output (x-axis). In blue the curve without the minimum load, which indicates a degree of efficiency of the amplifier in % of the higher performance range. (Figure 23)

power output would be the same as the power consumption. For the measurements sinusoidal signals were used, which may lead to slightly differing results in comparison to noise signals.

Figure 23 shows an alternative diagram where the degree of efficiency is demonstrated in percent on the y-axis. Due to the minimum load, the degree of efficiency for smaller power outputs turns out rather unfavorably. More interesting therefore is the blue curve, which arises if one leaves the minimum load out when calculating the degree of efficiency. Here, a maximum degree of efficiency of just under 80 % is achieved.

Additionally to the degree of efficiency, the form of the power consumption is also important for a good utilization of the power grid. The voltage is largely sinusoidal and in an ideal case, so is the current flow – comparable to a pure ohmic load. However, when switching power supplies, power tends to be consumed in short pulses. In other words, the current course will vary drastically from a sinusoidal course. This causes high current harmonics, which are described through the so-called distortion reactive power or the performance factor PF. In an ideal case, this would equal one, which means that the current course would equal the voltage course. To achieve the best

performance factor possible, a PFC (= Power Factor Correction) switch is included, which attempts to optimize the power consumption via the condenser block which acts as a buffer. In the X4 this is already quite successful. Figure 24 shows the voltage and power curve, which are very similar in their basic form. Depending on its load, the performance factor of the amplifier lays between 0.35 (non-load) and 0.97 (full load with sinusoidal signal). The amplifier is therefore a forgiving load for the power grid, which is especially important if they are supplied using generators.

Summary

With the two models of the X Series, the Italian manufacturer Powersoft present a 4- and an 8-channel amplifier with integrated DSP system, remote control and remote access as well as optional Dante audio network interface, which absolutely deserves the name loudspeaker management system. The DSP system offers an exceptionally large range of functions so that certainly nothing will be missed. The great Raised Cosine filter, several FIR filter possibilities and the diverse and precisely functioning limiters will let the hearts of loudspeaker developers beat faster. Abundant and also sensibly scaled performance is also available, allowing users to drive even large

Test | Powersoft X-Serie

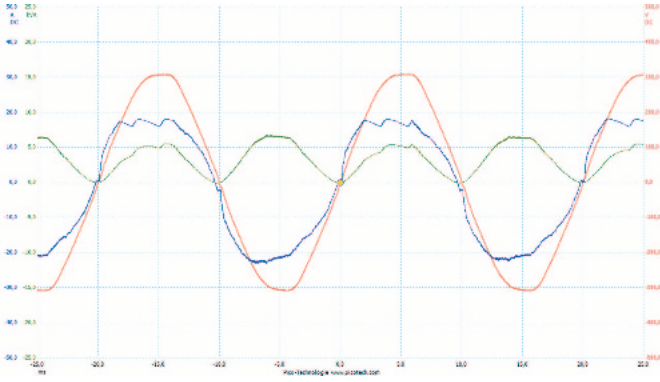

Main voltage (red), **power** (blue) and the **power consumption** calculated from these (green): To a large extent the PFC is clean, the current course equals the voltage course. (Figure 24)

PA systems. The features and the measurement values are also great. The Armonia Pro Audio Suite ensures control – even directly from mobile devices via web browser. As both are still in the development phase, the one or two uncertainties present with the software are sure to be fixed with the updated versions. In terms of price the amplifiers remain within the usual perimeters – the net price of the X4 costs 5,900 €, whereas the X8 is available for 9,490 € net price. A Dante interface is available for an additional 1,000 € net price.